



HEIGHTS		
Door	Standard Track Height	Low Profile Track Height
80"	82 3/4"	82"
92"	94 3/4"	94"
104"	106 3/4"	106"
116"	118 3/4"	118"

WIDTHS	
Door	Finished Opening
36"	135"
41"	155"
46"	175"



PLAN
open

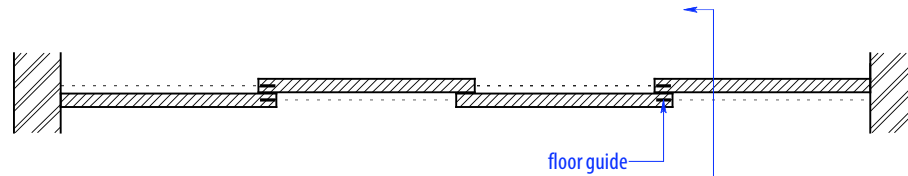

PLAN
closed

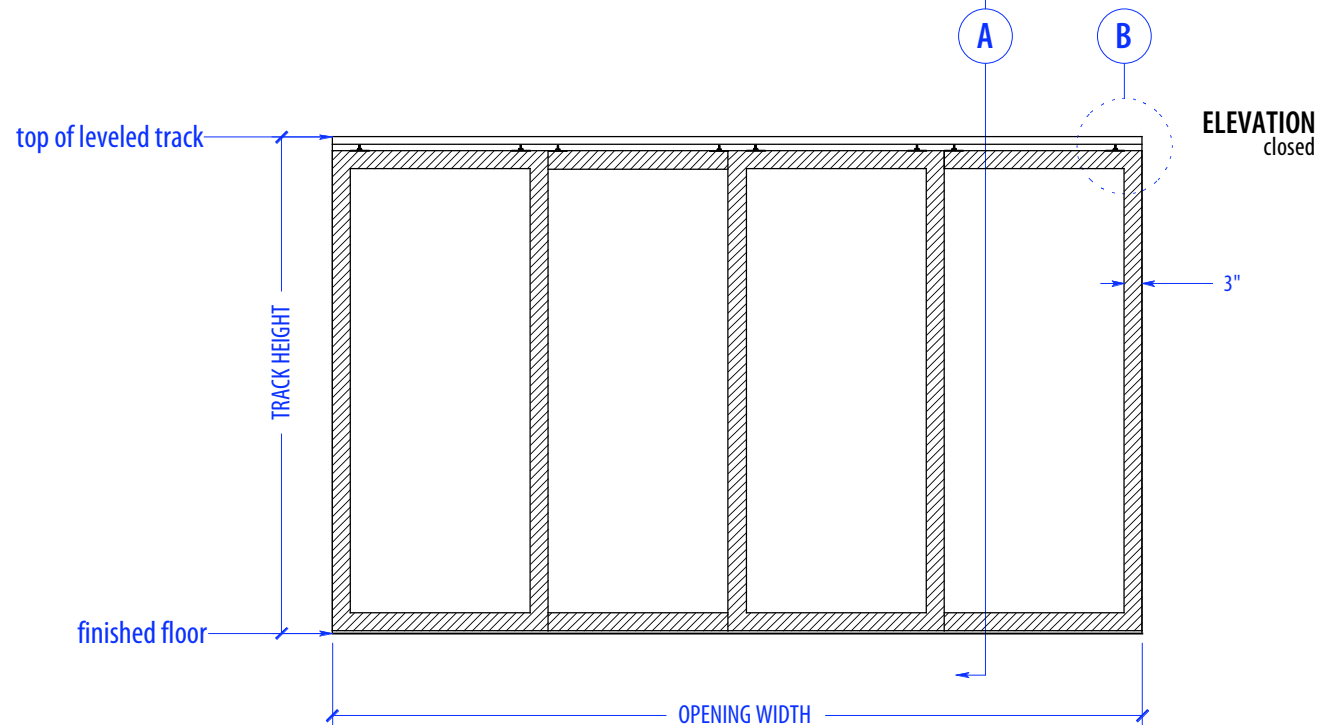

ELEVATION
closed



SECTION A

NOTE: each panel weighs approx. 75-110 lbs.
Secure tracks to blocking accordingly

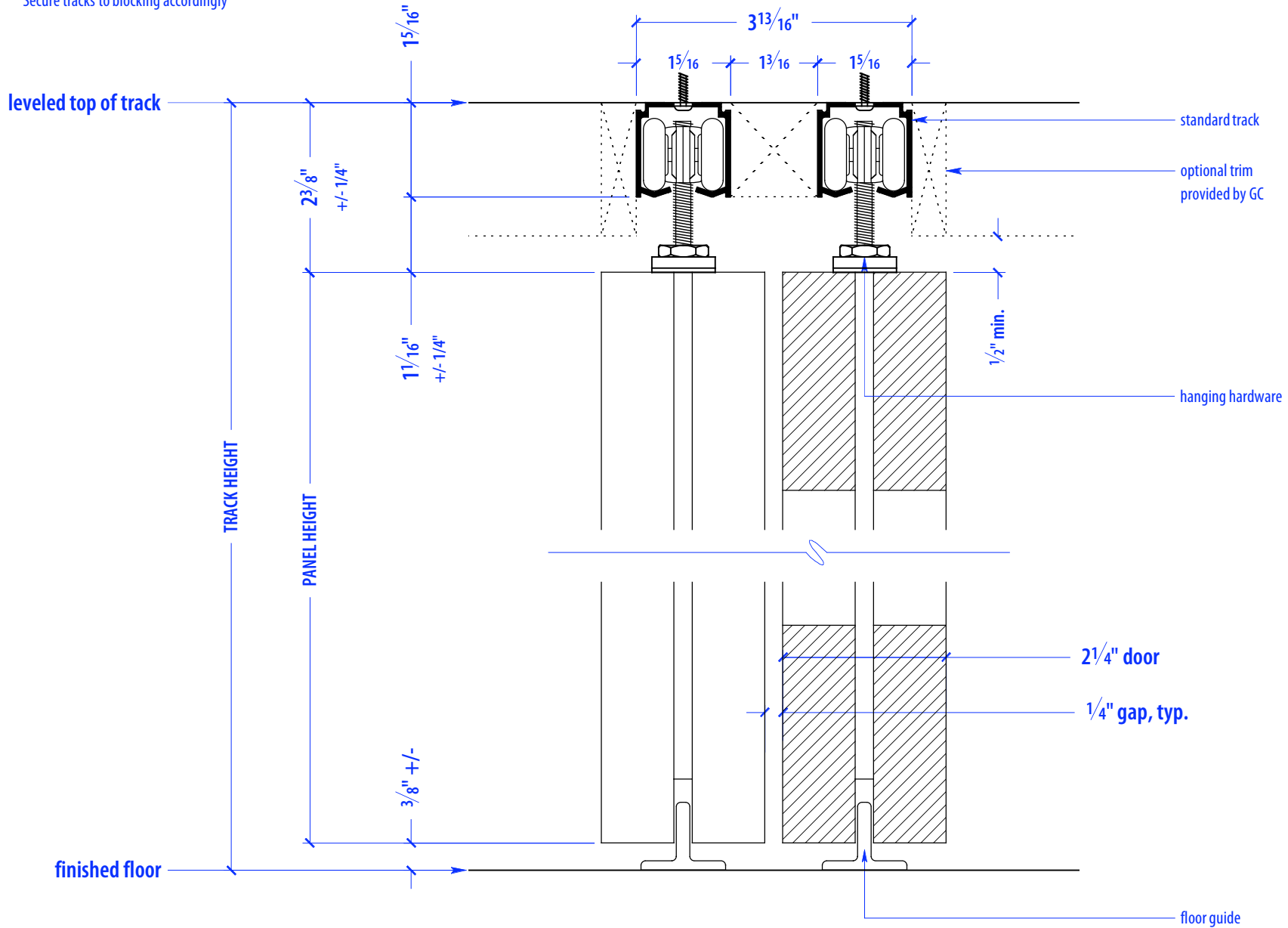



NOTE: each panel weighs approx. 75-110 lbs.
Secure tracks to blocking accordingly

SECTION B

