

(SPW) SLIDING POCKET WALL



Sliding Pocket Walls stack neatly in the cavity of a wall and make great room dividers. Lead door comes with an edge mounted ring pull to retrieve doors from pocket. Inside the pocket, is a floor mounted guide to help align and stabilize the doors. A pocket concealment panel added to the back edge of the trailing door conceals the gap left by the extracted panels for a clean finished look. Allow 3" for each overlapping stile.

Standard opening widths

System	Opening Widths *
SPW2	59", 69", 79", 89"
SPW3	87", 102", 117", 132"
SPW4	115", 135", 155", 175"
SPW4S	143", 138", 158", 178"
SPW6S	174", 204", 234", 264"

* Opening widths listed are from finished wall to finished wall.

Standard heights

Track	Opening Height *
Standard	83", 95", 107", 119"
Low Profile	82-1/4", 94-1/4", 106-1/4", 118-1/4"

* Opening heights are from finished floor to top of leveled track.

Panel models

225, 175, 175F

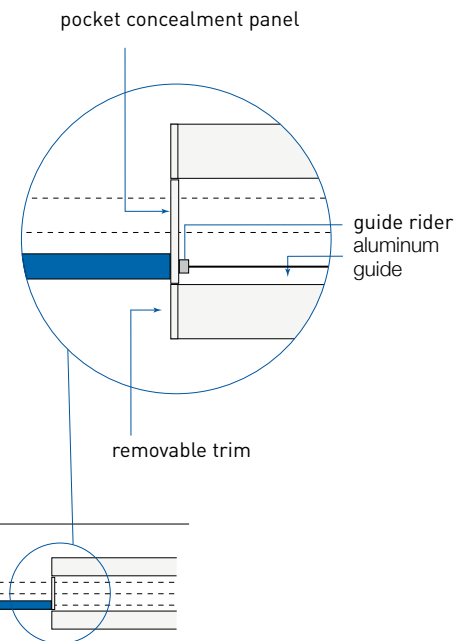
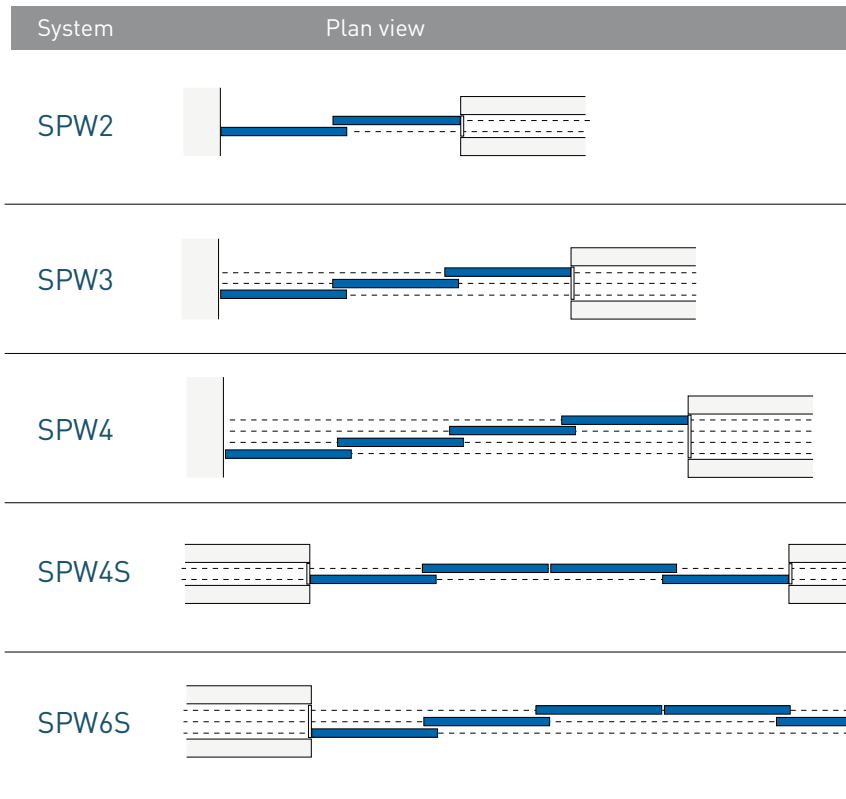

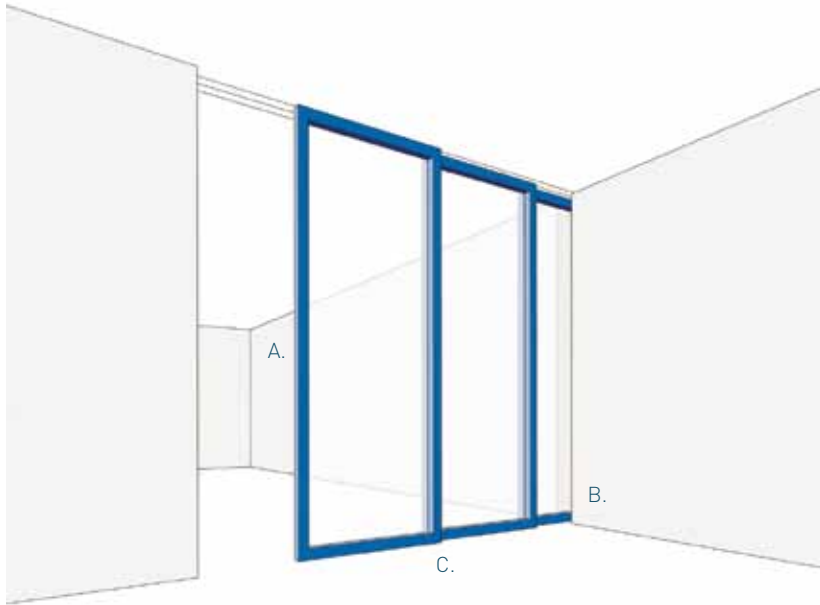

Operation Overview

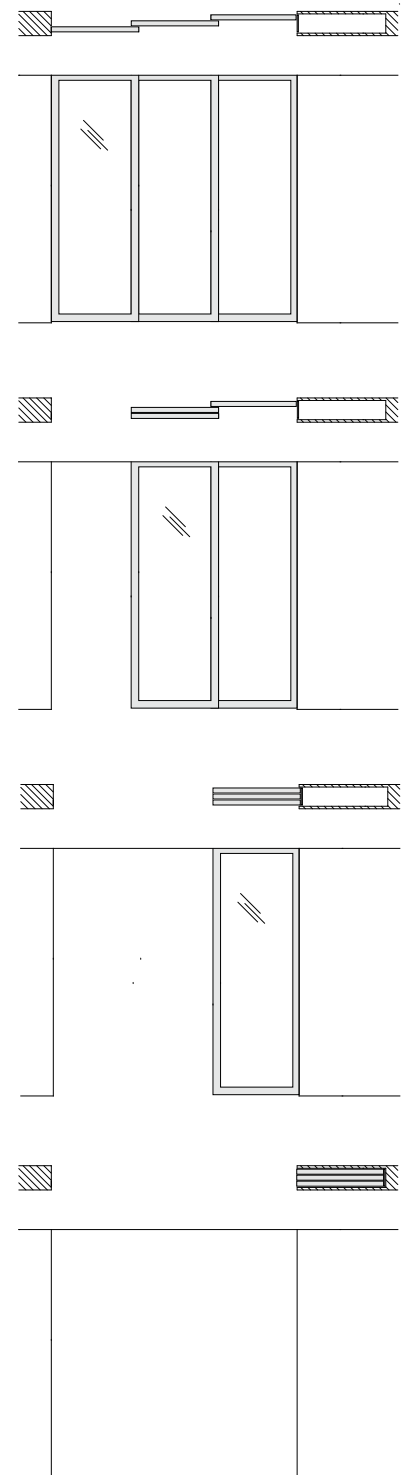

Features

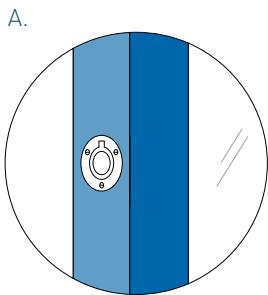

Edge mounted ring pull

Used to retrieve the lead door from the pocket

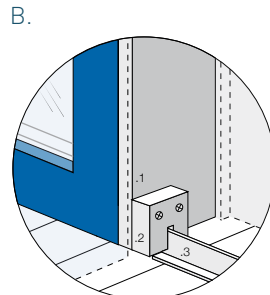

Pocket tracking & concealment

Conceals the empty pocket when doors are out and tracks the door into the pocket without rubbing or swaying.

1. a panel can be mounted on-site to the back of the trailing door to conceal the pocket when extended
2. nylon guide rider tracks the door on the guide and allows for full extension from the pocket
3. continuous aluminum floor mounted pocket guide keeps panel aligned within the pocket

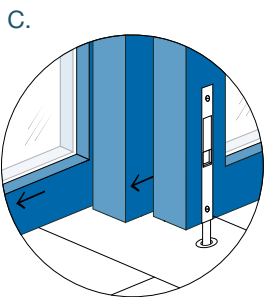

Telescoping RGST™ & stabilizing flush bolts

The Raydoor Guiding System™ allows one door to extract all the panels in one motion with no floor tracks. Mortised flush bolts and discreet spring loaded floor strikes provide stability.

