

# (SP) SLIDING POCKET



## Standard opening widths

System	Opening Widths *
SP1	31", 36", 41", 46"
SP2S	62", 72", 82", 92"

\* Opening widths listed are from finished wall to finished wall.

## Standard heights

Track	Opening Height *
Standard	83", 95", 107", 119"
Low Profile	82-1/4", 94-1/4", 106-1/4", 118-1/4"

\* Opening heights are from finished floor to top of leveled track.

Sliding Pocket doors are great for bedrooms, kitchens, baths, offices, pantries, closets and areas where narrow hallways restrict swing door movement. Comes with an edge mounted ring pull to retrieve door from pocket. A surface mounted pocket guide helps align and stabilize the door. Door fully extends from the pocket. Tracks and guides must be shipped in advance of pocket construction.

## Panel models

225, 175, 175F

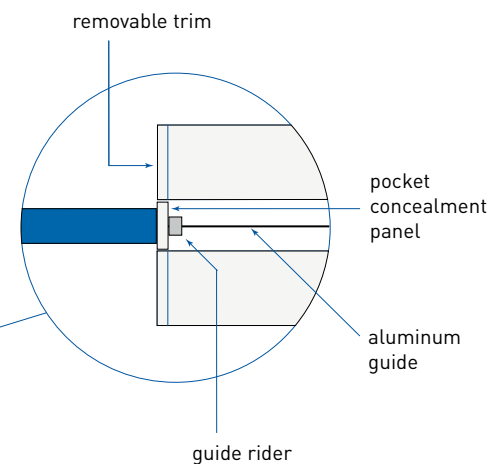
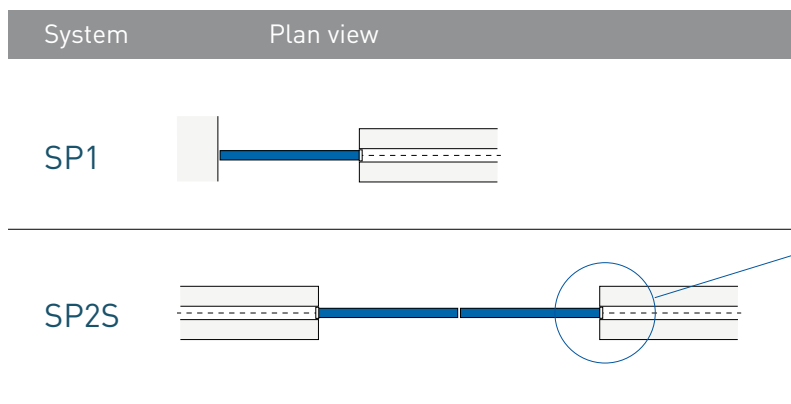

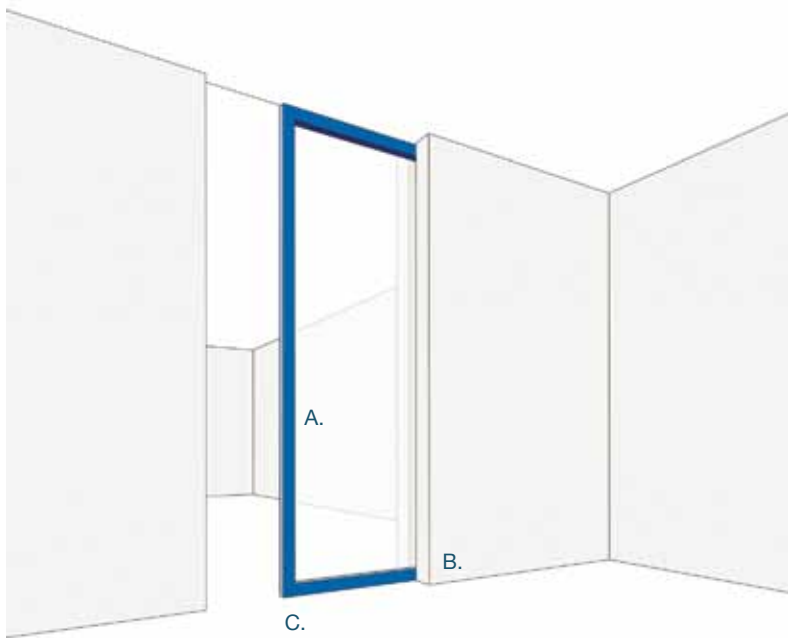

## Operation Overview

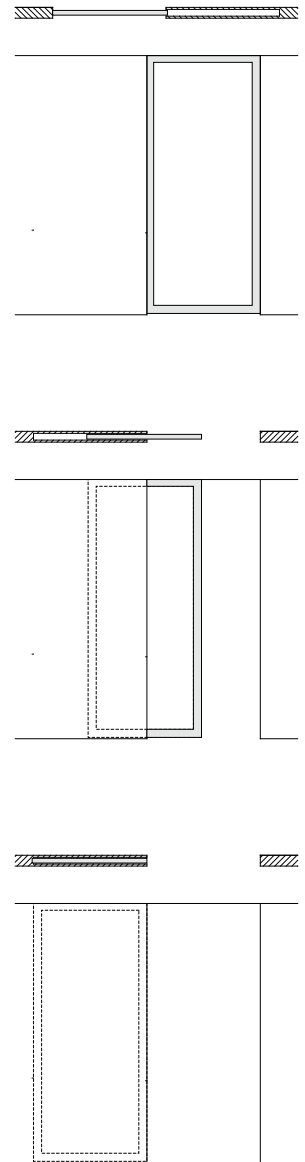

## Features

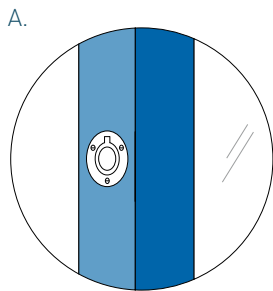

### Edge mounted ring pull

Used to retrieve the lead door from the pocket.

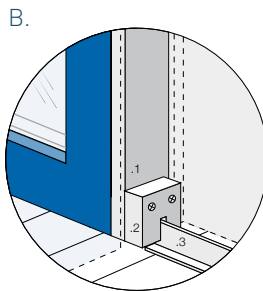

### Pocket tracking & concealment

Conceals the empty pocket when doors are out and tracks the door into the pocket without rubbing or swaying.

1. a panel can be mounted on-site to the back of the trailing door to conceal the pocket when extended
2. nylon guide rider tracks the door on the guide and allows for full extension from the pocket
3. continuous aluminum floor mounted pocket guide keeps panel aligned within the pocket

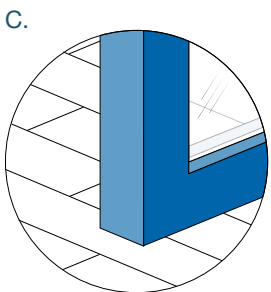

### No floor track required

Overhead tracks and the floor guide allow the door to slide across the opening easily and without the need for floor track.

